



EDGETEC® ATLANTIC SOFT CLOSE POOL GATE HINGE

NEW PREMIUM SOFT CLOSE HINGE FOR GLASS POOL FENCING

The Edgetec® Atlantic hinges combine incredible safety and sleek design into one premium quality product. Self-closing with a soft action, the Atlantic meets the requirements for New Zealand pool gate hinges without any compromise in design aesthetic, created with 2205 Duplex Stainless Steel the Atlantic is both durable and elegant.

+ SLEEK, MINIMALIST STYLE

Designed for 10 - 12mm Toughened glass pool fencing. Slim profile and no bulky anti-toe hold cap. Also suitable for up to 13.52mm SentryGlas®.

+ QUALITY FEATURES

With the Atlantic you get premium quality with adjustable soft close, single action, non-hold open functionality.

+ STRONGER FUNCTION

Duplex 2205 Stainless steel passes 640 hour salt spray test and 25,000 cycle test. Increased clamping force and closing action, with no retensioning of the spring required. Door weight max of 70kg.

+ FASTER, EASIER INSTALL

No adjustment required, one person can install and you don't need to remove or grease any screws.



530 Series GLASS GATE TO GLASS HINGE SET



PSS

SSS

BLK

- Duplex 2205 stainless steel
- Soft close with adjustable speed
- Single action
- Non-hold open
- Anti-foot hold

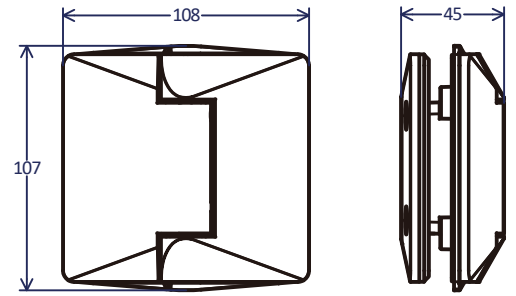
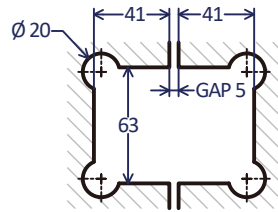

530 Series GLASS GATE TO WALL HINGE SET



PSS

SSS

BLK

- Duplex 2205 stainless steel
- Soft close with adjustable speed
- Single action
- Non-hold open
- Anti-foot hold

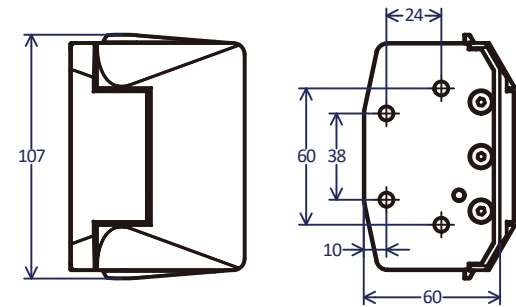
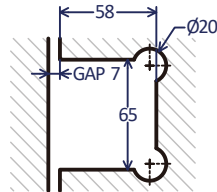

530 Series GLASS TO POST HINGE ADAPTOR

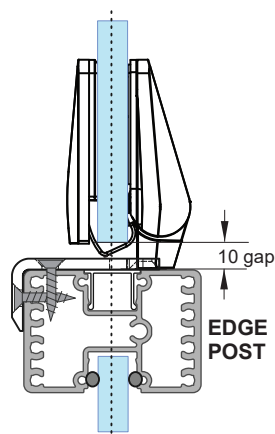

EDGE POST

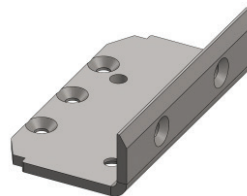
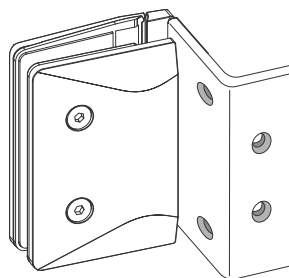

Juralco Adaptor Plate
ex 4mm SS JET/A530A65
Finish SCC only (Pair)

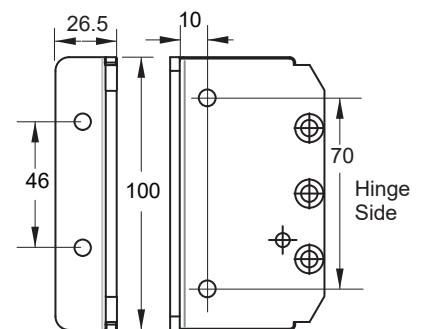

- Duplex 2205 stainless steel
- Soft close with adjustable speed
- Single action
- Non-hold open
- Anti-foot hold non-climbable
- Suitable for toughened glass 10-12mm, SentryGlas® 13.52mm
- Passed 25,000 cycle test

- Fixings included
- Passed 640 hour salt spray test
- Door Weight max 70kg (2 x Hinges min)
- Door Dimensions max H 2400 x W 950mm Internal
- Door Dimensions max H 1500 x W 950mm External
- Hinge Finishes are Satin, Mirror Polish, Satin Black (Satin White powdercoat and Satin Gold - special order only). Adaptor Plate Powder coat only.